

**BALCÃO 01 PORTA 04 GAVETAS
NESHER IMPERATRIZ 120 CM 100% MDF**

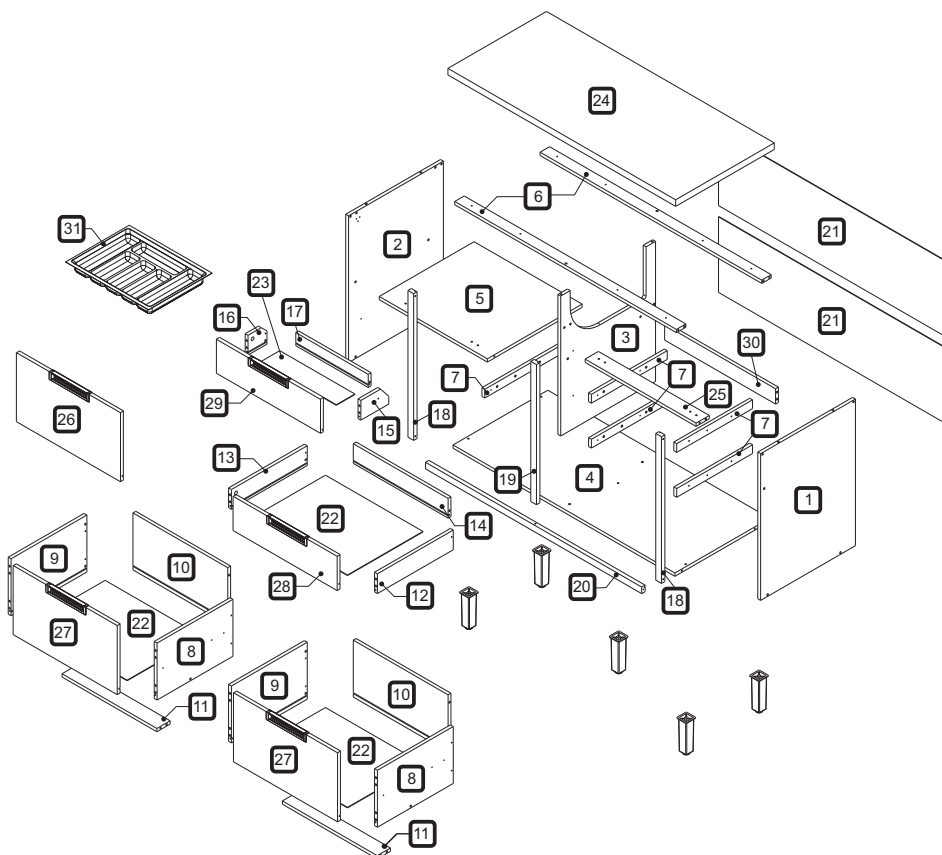

DIMENSÕES DOS ESPAÇOS INTERNOS (MEDIDAS EM MILÍMETRO)

DIMENSÕES MÁXIMAS DO PRODUTO MONTADO

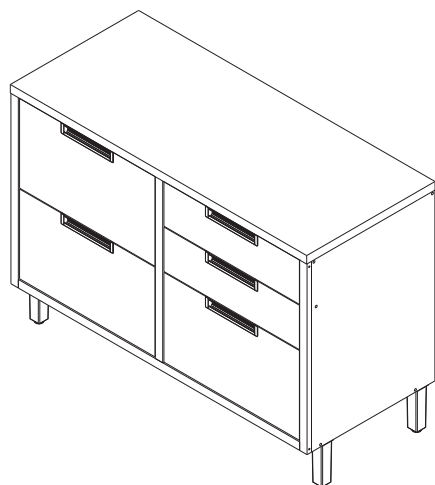
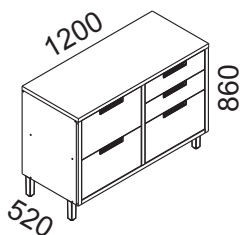





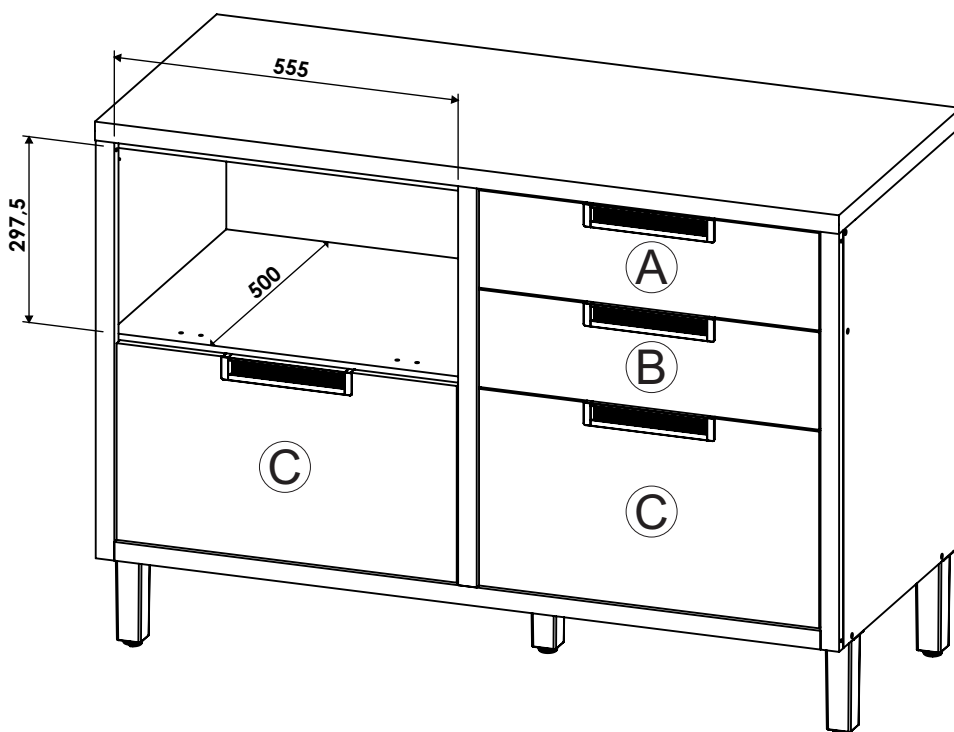



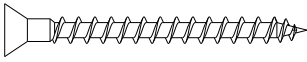
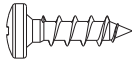
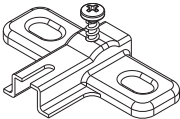
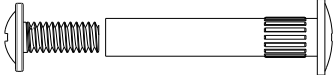
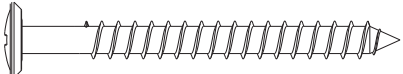

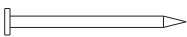
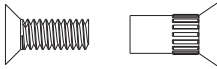
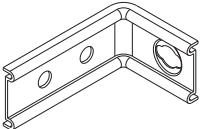
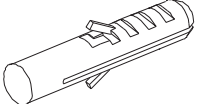
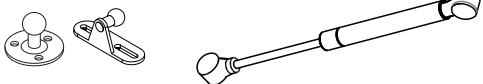
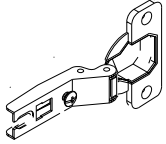

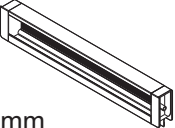
**ESPAÇO INTERNO DAS GAVETAS
(largura x altura x profundidade)**



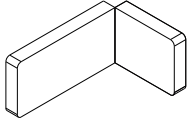
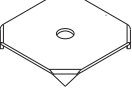

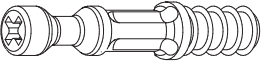
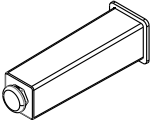
- Ⓐ 382 x 78 x 85 mm
- Ⓑ 500 x 78 x 385 mm
- Ⓒ 500 x 242 x 385 mm

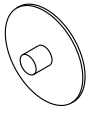
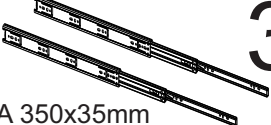
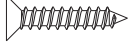
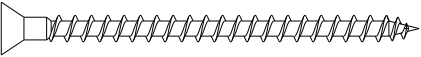
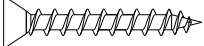

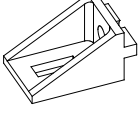
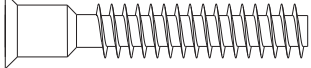
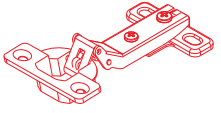
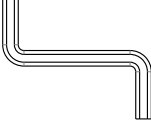
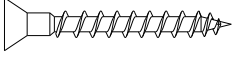
CÓDIGO	DESCRIÇÃO	QTDE	COMP.	LARG.	ESP.
1	LATERAL DIREITA	1	670	500	15
2	LATERAL ESQUERDA	1	670	500	15
3	DIVISÃO	1	639	500	15
4	BASE	1	1.170	500	15
5	PRATELEIRA	1	570	500	15
6	TRAVESSA SUPERIOR	2	1.169	50	15
7	AFASTADOR DE GAVETA	5	400	40	15
8	LATERAL DIREITA DE GAVETA MAIOR	2	400	260	15
9	LATERAL ESQUERDA DE GAVETA MAIOR	2	400	260	15
10	TRASEIRO DE GAVETA MAIOR	2	500	260	15
11	TRAVESSA DE GAVETA MAIOR	2	500	70	15
12	LATERAL DIREITA DE GAVETA MENOR	1	400	90	15
13	LATERAL ESQUERDA DE GAVETA MENOR	1	400	90	15
14	TRASEIRO DE GAVETA MENOR	1	500	90	15
15	LATERAL DIREITA DE GAVETA COND.	1	147	90	15
16	LATERAL ESQUERDA DE GAVETA COND.	1	100	90	15
17	TRASEIRO DE GAVETA COND.	1	382	60	15
18	MOLDURA LATERAL	2	670	30	18
19	MOLDURA CENTRAL	1	640	30	18
20	MOLDURA INFERIOR	1	1.140	30	18
21	FUNDO TRASEIRO	2	1.195	348	2,5
22	FUNDO DE GAVETA	3	514	398	2,5
23	FUNDO DE GAVETA COND.	1	396	98	2,5
24	BANCADA	1	1.201	520	30
25	TRAVESSA FRONTAL	1	585	70	15
26	PORTA BASCULANTE	1	549	315	15
27	FRENTE DE GAVETA MAIOR	2	549	315	15
28	FRENTE DE GAVETA MENOR	1	549	156	15
29	FRENTE DE GAVETA COND.	1	549	156	15
30	TRAVESSA TRASEIRA	1	585	70	15
31	PORTA TALHERES	1	499	384	60

CÓDIGO/DESCRIÇÃO	QUANTIDADE	CÓDIGO/DESCRIÇÃO	QUANTIDADE
A  PARAFUSO 3,5x40mm CABEÇA CHATA	12	B  PARAFUSO 4x14mm CABEÇA PANELA	52
C  CALÇO PARA DOBRADIÇA 35mm	2	D  PARAFUSO UNIAO DE MÓDULOS 28MM	3
E  PARAFUSO 5x50mm CABEÇA FLANGEADA	11	F  CAVILHA 8x30mm	42
G  PREGO 10x10 COM CABEÇA	44	H  PARAFUSO DE UNIÃO 17mm	8
I  CANTONEIRA METALICA PARA FIXAÇÃO NA PAREDE	6	J  BUCHA DE PAREDE DE 8mm	6
K  PISTÃO A GÁS 60N INVERSO	1	L  DOBRADIÇA ALTA CANECO 35mm	2
M  BATENTE DE SILICONE	4	N  PUXADOR 211 mm - FURAÇÃO 160 mm	5

<p>O</p> <p>TAPA FURO ADESIVO 12mm</p>  <p>32</p>	<p>P</p> <p>CAPA PLÁSTICA PARA CANTONEIRA</p>  <p>6</p>
<p>Q</p> <p>FIXADOR FUNDO TRASEIRO METÁLICO</p>  <p>6</p>	<p>R</p> <p>DISPOSITIVO FIXADOR DE FUNDO</p>  <p>12</p>
<p>S</p> <p>PARAFUSO MINIFIX</p>  <p>12</p>	<p>T</p> <p>PÉS</p>  <p>5</p>
<p>U</p> <p>TAMBOR MINIFIX</p>  <p>12</p>	<p>V</p> <p>TAMPA MINIFIX</p>  <p>12</p>
<p>W</p> <p>PAR CORREDIÇA TELESCÓPICA 350x35mm</p>  <p>3</p>	<p>X</p> <p>PARAFUSO 3X16mm CABEÇA CHATA</p>  <p>12</p>
<p>Y</p> <p>PARAFUSO 3,5X50mm CABEÇA CHATA</p>  <p>3</p>	<p>Z</p> <p>PARAFUSO 3,5 X 25mm CABEÇA CHATA</p>  <p>15</p>
<p>A1</p> <p>PARAFUSO 3,5X14mm CABEÇA CHATA</p>  <p>46</p>	<p>A2</p> <p>SUPORTE ANGULAR</p>  <p>13</p>
<p>A3</p> <p>PARAFUSO 7x40mm CABEÇA CHATA</p>  <p>22</p>	<p>A4</p> <p>DOBRADIÇA SLOW MOTION COM CALÇO ALTA CANECO 35mm</p>  <p>2</p>
<p>A5</p> <p>CHAVE ZETA</p>  <p>1</p>	<p>A6</p> <p>PARAFUSO 3,5x30mm CABEÇA CHATA</p>  <p>8</p>

<p>Ferramentas para montagem e instalação</p>    <p>PARAFUSADEIRA FURADEIRA NÍVEL</p>    <p>TRENA MARTELO CHAVE PHILIPS E FENDA</p> <p>Montagem</p>  <p>Instalação</p> 	<p>PASSO 1</p> <p>1 - Alinhar o pé T com o furo da base 4 e fixá-los com os parafusos E (5x50mm)</p>  <p>T 5</p> <p>E 5</p>
--	---

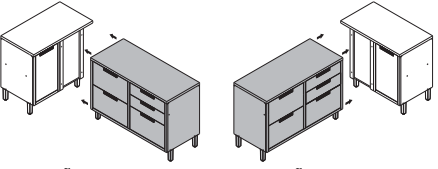
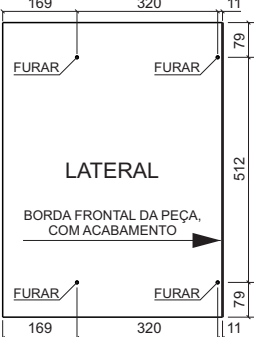
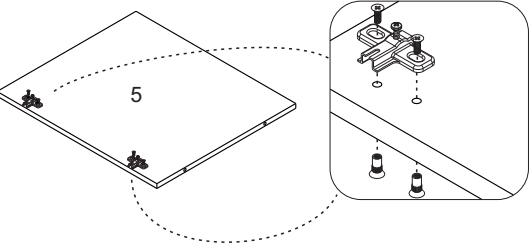
<p>ATENÇÃO</p> <p>Para realizar a união deste produto com o balcão de canto, faça as furações vazadas na lateral que ficará faceada com o balcão de canto, utilizando broca de 6mm, antes de iniciar a montagem do produto, conforme orientação abaixo:</p>  <p>BALCÃO DE CANTO DO LADO ESQUERDO: Furar lateral esquerda</p> <p>BALCÃO DE CANTO DO LADO DIREITO: Furar lateral direita</p>  <p>LATERAL</p> <p>BORDA FRONTAL DA PEÇA, COM ACABAMENTO</p> <p>OBS.: Medidas em milímetro</p>	<p>PASSO 2</p> <p>1 - Fixar os calços C na prateleira 5 utilizando os parafusos de união H (17mm)</p>  <p>C 2</p> <p>H 4</p>
---	--